

salton®

Microwave Oven



Instruction Booklet

Model: MW-2024

IMPORTANT SAFETY INSTRUCTIONS

IMPORTANT SAFEGUARDS

When using electrical appliances, basic safety precautions should be followed, including the following:

WARNING! - To reduce the risk of burns, electric shock, fire, injury to persons, or exposure to excessive microwave energy:

1. Read all instructions before using the appliance.
2. Read and follow the specific "PRECAUTIONS TO AVOID POSSIBLE EXPOSURE TO EXCESSIVE MICROWAVE ENERGY" in the section on page 5.
3. This appliance must be grounded. Connect only to a properly grounded outlet. See the "GROUNDING INSTRUCTIONS" section on page 6.
4. Install or locate this appliance only in accordance with the provided installation instructions in the "INSTALLATION" section on page 11.
5. DO NOT cover or block any vents on this appliance.
6. DO NOT store or use this appliance outdoors. Do not use this product near water, for example, near a kitchen sink, in a wet basement, or near a swimming pool or similar locations.
7. Use this appliance only for its intended use as described in this manual. DO NOT use corrosive chemicals or vapors in this appliance. This type of oven is specifically designed to heat, cook or dry food. It is not designed for industrial or laboratory use. The use of corrosive chemicals in heating or cleaning will damage the appliance and may result in radiation leaks.
8. When cleaning surfaces of door and oven that come together when closing the door, use only mild, nonabrasive soaps or detergents applied with a sponge or soft cloth.
9. DO NOT allow children to use this appliance, unless closely supervised by an adult.
10. DO NOT operate this appliance if it has a damaged cord or plug, if it is not working properly, or if it has been damaged or dropped.
11. DO NOT immerse cord or plug in water.
12. Keep cord away from heated surfaces.
13. DO NOT let cord hang over edge of table or counter.

14. This appliance should only be serviced by qualified service personnel. See the Warranty section or contact the your nearest service facility for examination, repair or adjustment.
15. DO NOT attempt to tamper with or make any adjustments or repairs to oven door, control panel or any other part of the oven. DO NOT remove outer casing from oven.
16. Some products such as whole eggs sealed containers and closed glass jars, may explode and should not be heated in this oven.
17. To reduce the risk of fire in the oven cavity:
 - a. DO NOT overcook food.
 - b. DO NOT leave the microwave unattended if paper, plastic or other combustible materials are placed inside the oven to facilitate cooking.
 - c. Remove wire twist-ties from paper or plastic bags before placing bag in oven.
18. If materials inside the oven should ignite,
 - a. Keep oven door CLOSED
 - b. Turn oven off
 - c. Disconnect the power cord or shut off power at the fuse or circuit breaker panel
19. Liquids, such as water, coffee, or tea are able to be overheated beyond the boiling point without appearing to be boiling due to surface tension of the liquid. Visible bubbling or boiling when the container is removed from the microwave oven is not always present. THIS COULD RESULT IN VERY HOT LIQUIDS SUDDENLY BOILING OVER WHEN A SPOON OR OTHER UTENSIL IS INSERTED INTO THE LIQUID. To reduce the risk of injury to persons:
 - a) DO NOT overheat the liquid.
 - b) Stir the liquid both before and halfway through heating it.
 - c) DO NOT use straight-sided containers with narrow necks.
 - d) After heating, allow the container to stand in the microwave oven for a short time before removing the container.
 - e) Use extreme care when inserting a spoon or other utensil into the container.

20. Pot Holders should always be used when removing items from the oven. Heat is transferred from hot food to the cooking container and from the container to the Glass Tray. The Glass Tray can also be very hot after removing the cooking container from the oven.

WARNING!

TO AVOID THE RISK OF FIRE

1. DO NOT operate the oven empty. The microwave energy will reflect continuously throughout the oven causing overheating and damage, if food or water is not present to absorb energy.
2. DO NOT store flammable materials next to, on top of, or in the oven.
3. DO NOT dry clothes, newspapers or other materials in the oven. Or use newspaper or paper bags for cooking.
4. DO NOT hit or strike the Control Panel. Damage to the controls may occur.
5. DO NOT use recycled paper products unless the paper product is labeled as safe for microwave oven use. Recycled paper product may contain impurities which may cause arcing.
6. Do not use the cavity for storage purposes. Do not leave paper products, cooking utensils or food in the cavity when not in use.
7. Do not use this microwave oven to heat corrosive chemicals (for example, sulfides and chlorides). Vapors from such corrosive chemicals may interact with the contact and springs of the safety interlock switches thereby rendering them inoperable.
8. Keep the Waveguide Cover (mica sheet) clean at all times. Wipe the oven interior with a soft damp cloth after each use. If you leave grease or fat anywhere in the cavity it may overheat, smoke or even catch fire when next using the oven.
9. Never heat oil or fat for deep frying as you cannot control the temperature and doing so may lead to overheating and fire.
10. This appliance is intended for HOUSEHOLD USE ONLY.

GLASS TURNTABLE

1. Do not cook directly on the turntable. It can crack, cause injury or damage to the oven. Always place food in a microwave safe dish.
2. DO not operate the oven without the Glass Turntable in place. Improper cooking or damage to the oven could result. Verify that the Glass Turntable is properly engage and rotating by observing its rotation when you press Start.
3. Use the Glass Turntable specifically designed for this oven.
DO NOT substitute any other glass tray.
4. If the Glass Tray is hot, allow to cool before cleaning or placing in water.

PRECAUTIONS TO AVOID POSSIBLE EXPOSURE TO EXCESSIVE MICROWAVE ENERGY

1. Do not attempt to operate this oven with the door open as open-door operation can result in harmful exposure to microwave energy. It is important not to defeat or tamper with the safety interlocks.
2. Do not place any object between the oven front face and the door or allow soil or cleaner residue to accumulate on sealing surfaces.
3. Do not operate the oven if it is damaged. It is particularly important that the oven door closes properly and that there is no damage to the following:
 - a) door (bent)
 - b) hinges and latches (broken or loosened)
 - c) door seals and sealing surfaces.

The oven should not be adjusted or repaired by anyone except properly qualified service personnel.

GROUNDING INSTRUCTIONS

This appliance must be grounded. In the event of an electrical short circuit, the grounding plug reduces the risk of electric shock by providing an escape wire for electric current. This appliance is equipped with a cord having a grounding wire with a grounding plug. The plug must be plugged into an outlet that is properly installed and grounded. It is recommended that a separate circuit serving only the oven be provided.

WARNING – Improper use of grounding can result in a risk of electric shock. DO NOT cut or remove the third (ground) prong from the power cord under any circumstances.

Consult a qualified electrician or serviceman if the grounding instructions are not completely understood or if doubt exists as to whether the appliance is properly grounded.

Do not use an extension cord. If the power supply cord is too short, have a qualified electrician or serviceman install an outlet near the appliance.

NOTE: A short power cord is provided to reduce the risk of the user becoming entangled in or tripping over a longer cord. Longer cord sets or extension cords are available and may be used if care is exercised in their use. If an extension cord is used, the marked electrical rating of the cord should be at least as great as the electrical rating of the oven. The extension cord must be a grounding-type 3-wire cord. The longer cord should be arranged so it does not drape over the table top or counter when children can pull on it or trip over it.

Using an Adapter

Due to potential safety hazards, we strongly recommend against the use of an adapter plug. However, if you choose to use an adapter, where local codes may permit, a temporary connection may be made to a properly grounded two prong wall outlet by the use of a cUL/CSA listed adapter, which is available at most hardware stores.

GENERAL USE

Arcing

Arcing is the microwave term for sparks in the oven. If you see arcing, press the Stop/Clear pad immediately and correct the problem. Arcing is caused by the following:

1. Metal or foil touching the side of the microwave
2. Uprturned edges of foil not wrapped around the food
3. Metals in the microwave such as twist ties, meat pins or metal rimmed dishes
4. Recycled paper towels

Guidelines and safety tips for microwave cooking:

1. DO NOT operate the oven empty. The microwave energy will reflect continuously throughout the oven if no food or water is present to absorb energy.
2. DO NOT attempt to dry clothes, newspapers or other materials in the oven. They may catch on fire.
3. Do NOT use recycled paper products. Recycled paper towels, napkins and waxed paper can contain metal flecks which may cause arcing or ignite. Paper products containing nylon or nylon filaments should be avoided, as they may ignite.
4. Some Styrofoam trays (like those that meat is packaged on) have a thin strip of metal embedded on the bottom. When microwaved, the metal can burn the floor of the oven or ignite a paper towel.
5. DO NOT use sealed jars or narrow neck bottles for cooking or reheating. They may shatter.

6. Remove plastic store wrap before cooking or defrosting foods in the oven.
7. Avoid inserting nails, wire, etc. through any holes in the unit during operation. Never insert a wire, nail or any other metal objects through the holes on the cavity or any other holes or gaps, because such objects may cause electric shock and microwave leakage.
8. DO NOT leave the microwave unattended when paper, plastic or other combustible materials are placed inside the oven to facilitate cooking.
9. DO NOT use the oven cavity for storage purposes.
10. DO NOT store combustible items such as bread, cookies, paper products, etc. inside the oven.
11. Remove the wire twist-ties and metal handles from paper or plastic containers/bags before placing them in the oven.
12. The contents of feeding bottles and baby food jars should be stirred or shaken and the temperature should be checked before serving in order to avoid burns.
13. Cooking utensils may become hot because of heat transferred from the heated food. Potholders may be needed to handle the utensil.
14. Use only thermometers that are specifically designed for use in microwave ovens.
15. DO NOT operate any heating or cooking appliances beneath this appliance.
16. The glass tray and roller ring must be in place when you operate the oven.
17. Never use your microwave oven for HOME CANNING. The oven is not designed to permit proper canning. Improperly canned food may spoil and be dangerous to consume.
18. DO NOT overcook food. If food is undercooked, it can always be returned to the oven for further cooking. If food is overcooked, nothing can be done. Always start with minimum cooking times.
19. Small quantities of food or foods with low moisture content can burn, dry out or catch on fire if cooked too long.

20. DO NOT boil eggs in their shell. Pressure may build up and the eggs may explode.
21. Potatoes, apples, egg yolks, whole acorn squash and sausage are some examples of food with nonporous skins. These must be pierced before cooking to prevent bursting.
22. POPCORN must be popped in a microwave corn popper. Microwave popped corn produces a lower yield than conventional popping. DO NOT use oven for popcorn unless popped in a microwave approved popcorn utensil or unless it's commercially packaged and recommended especially for microwave ovens. DO NOT use oil unless specified by the manufacturer.
23. DO NOT attempt to deep fat fry in your oven.
24. HEATED LIQUIDS can ERUPT if not mixed with air. DO NOT heat liquids in your microwave oven without stirring.

UTENSILS

CAUTION:

Personal Injury Hazard

Tightly closed utensils could explode. Closed containers should be opened and plastic pouches should be pierced before cooking.

See the instructions in the chart on page 10, 'Utensils for Use in the Microwave' and the section 'Utensils to Avoid in the Microwave'. When in doubt if a utensil is safe for microwave use, you can test the utensil in question by following the procedure below.

Utensil Test:

Fill a microwave-safe container with 1 cup (250 ml) of cold water along with the utensil in question. Cook on maximum power for 1 minute. Carefully feel the utensil. If the empty utensil is warm, do not use it for microwave cooking. Do not exceed 1 minute cooking time.

To avoid arcing (see the Arcing section) and other hazards, use the recommended utensils in the 'Utensils for Use in the Microwave' section on page 10.

Utensils for Use in the Microwave

Aluminum foil	Use for shielding only. Small smooth pieces can be used to cover thin parts of meat or poultry to prevent overcooking. Arcing can occur if foil is too close to oven walls. The foil should be at least 1 inch (2.5 cm) away from oven walls.
Browning dish	Use to brown the exterior of small items such as steaks, chops or pancakes. Follow the directions provided with your browning dish.
Ceramic, porcelain, stoneware	Use microwave safe only. Do not use cracked or chipped dishes. Never use dishes with metal trim.
Glassware	Microwave safe only. Follow manufacturer's instructions. Do not use cracked or chipped dishes.
Oven cooking bags	Follow manufacturer's instructions. Do not close with metal tie. Make slits to allow steam to escape.
Paper plates/cups	Use for short-term cooking/warming only. Do not leave oven unattended while cooking. Do not use recycled paper as they may contain metal and can catch fire.
Paper towels	Use to cover food for reheating and absorbing fat. Use with supervision for short-term cooking only. DO NOT use recycled paper towels as they may contain metal and can catch fire.
Parchment paper	Use as a cover to prevent splattering or a wrap for steaming.
Plastic	Only use plastic marked microwave-safe. Other plastics may soften as the food inside gets hot. "Boiling bags" and tightly closed plastic bags should be slit, pierced or vented.
Plastic wrap	Microwave-safe only. Use to cover food during cooking to retain moisture. Leave a small opening for steam to escape. Do not allow plastic wrap to touch food.
Thermometers	Microwave-safe only. (meat and candy thermometers)
Wax paper	Use to cover food to prevent splattering and retain moisture.

Utensils to AVOID in the Microwave

DO NOT use the following materials in the microwave:

- Metal or aluminum pans/bakeware, utensils
- Recycled paper products
- Non-heat resistant glass
- Food storage bags
- Dishes with metallic trim
- Brown paper bags
- Non-microwave-safe plastics, such as margarine tubs
- Metal twist-ties
- Glass jars and bottles
- Styrofoam plates and cups
- Wood

SAVE THESE INSTRUCTIONS

INSTALLATION

1. Remove all packing materials and accessories. Remove any protective film found on the microwave oven cabinet surface and on the Control Panel. **IMPORTANT:** Do not remove the Waveguide on the inside of the oven cavity, this is to protect the magnetron.
2. Examine the oven for any damage after unpacking. Check for damage such as a misaligned door, broken door or dents in the cavity. Do not install if there is any damage.
3. Install the microwave oven on a flat, level surface that provides at least 3" (7.5 cm) of space on the side and back of the microwave oven and at least 12" (30cm) above the oven. One side must be open. Never remove the legs from the bottom of the microwave oven. Blocking the intake and/or outlet openings can damage the oven.
4. Place the microwave as far away as possible from radios and televisions. The microwave oven may cause interference with these products.

5. DO NOT install the oven over a range cook-top or other heat-producing appliances or near water taps. Heat and water can damage the microwave and void the warranty.
6. Plug the microwave oven into a standard household grounded outlet. Check the rating label of the microwave to ensure the voltage and frequency are compatible with the rating of the outlet. (See Grounding Instructions on page 6)

DESCRIPTION OF PARTS

- 1) Cabinet
- 2) See thru Oven Window
- 3) Turntable Assembly
 - a) Turntable Drive Shaft
 - b) Roller Ring
 - c) Glass Tray
 - d) Hub (under Glass Tray)
- 4) Waveguide/Mica Cover (Do not remove)

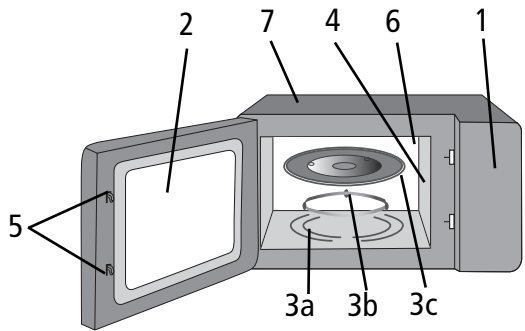

- 5) Door Safety Lock System
- 6) Oven Light
- 7) Air Vent
- 8) Control Panel
 - a) Display
Shows cooking time, power and present time
 - b) Pre-programmed One-Touch cook pads
Instant settings to cook 8 popular foods
 - c) Defrost by Weight
 - d) Power
 - e) Timed Defrost
 - f) Number Buttons
Touch to set times or weights

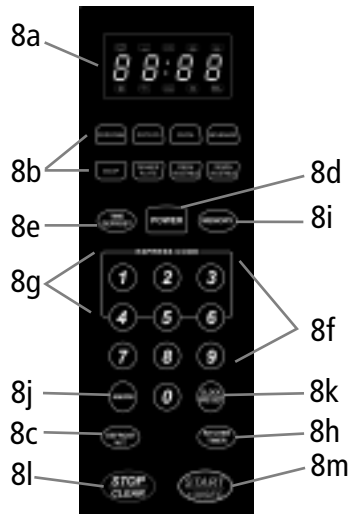

- g) 1 – 6 Express Cook touch pads
- h) Kitchen Timer
- i) Memory
- j) AM/PM
- k) Clock/Pre-Set

Use to set the time of day or recall the time of day

- l) Stop/Clear

Clears all previous settings pressed before cooking starts. During cooking press once to stop the oven and twice to stop and clear all entries

- m) Start/+30sec

Turntable Assembly

1. Hub (underside of glass tray)
2. Glass Tray
3. Turntable Ring
4. Turntable Shaft

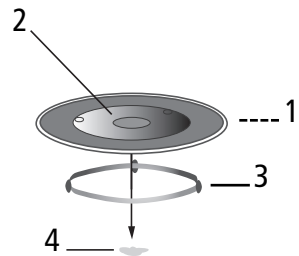

Center the Turntable Ring over the Turntable Shaft on the floor of the microwave oven. Install the Glass Tray, centering the Hub over the Turntable Shaft. Turn the Glass Tray slowly until the Hub engages on the Turntable Shaft.

- Never place the glass tray upside down. The glass tray should never be restricted.
- Both the Glass Tray and Turntable Ring must be used during cooking.
- Place all containers with food on the Glass Tray for cooking.
- Verify that the Glass Tray is properly engaged and rotating by observing its rotation when you press Start. **NOTE:** The Glass Tray can turn in either direction.
- If the Glass Tray or Turntable Ring cracks or breaks, contact SWG Canada. (See Warranty)

OPERATING INSTRUCTIONS



Setting the Clock

1. When the microwave oven is plugged into the outlet, the oven will display "0.00"
2. Press "CLOCK/PRE-SET", and the LED will display 00:00 and the clock indicator icon  will light up in the Display Window. The numbers will flash starting with the first hour digit.
3. Press the number pads and enter the correct time. For example, to set the time of 11:30, press the numbers 1,1,3 & 0, one at a time.
4. Press 'AM/PM' to choose AM or PM.
5. Press CLOCK/PRE-SET to finish setting the clock. The clock indicator will go out and the ':' will be flashing. The clock icon will go out.

NOTE:

- If the numbers that are input are not within a time range then the setting will not be valid and the clock will not be set.
- In the process of setting the clock, if STOP/CLEAR is pressed or if there is no operation within 1 minute, the oven will go back to the former setting automatically.

Setting the Kitchen Timer



1. Press KITCHEN TIMER and 00:00 and the clock indicator icon  will light up in the Display Window.
2. Press the number keys and enter the desired time. The maximum time is 99 minutes and 99 seconds. NOTE: To set less than a 4 digit time (Ex. 1 minute 30 seconds) the first digit should be a '0' (0130)
3. Press START/+30 SEC to confirm the setting and start the timer. The clock icon  will show in the Display Window.
4. When the preset time has expired the clock icon  will go out and a 'beep' will sound 5 times.

Setting the Child Lock



Press STOP/CLEAR and hold for 3 seconds and the child lock icon  will appear. The microwave will beep and the time will no longer be displayed in the Display Window. You will not be able to enter any information on the Control Panel or use the Microwave.

To unlock the Control Panel, press STOP/CLEAR for 3 seconds. The microwave will beep and the time will be shown in the Display Window. You can now use the Microwave.

Selecting Power Level and Cook Time



10 power levels are available. When a power between level 8 – 10 is chosen, the high level icon  is shown in the Display Window. When a power level 1 – 7 is chosen the low level icon  will be shown in the Display Window.

Level	10	9	8	7	6	5	4	3	2	1
Power	100%	90%	80%	70%	60%	50%	40%	30%	20%	10%
Display	PL10	PL9	PL8	PL7	PL6	PL5	PL4	PL3	PL2	PL1

1. Press POWER once for power level 10, twice for power level 9, 3 times for power level 8, etc. The Cooking icon  will show in the display window along with the high or low icon  or .
2. Press the number pads to input the cooking time. **NOTE:** The maximum cooking time is 99 minutes and 99 seconds.
3. Press START/+30SEC to start cooking. The remaining cooking time will be shown in the Display Window. To increase the cooking time in 30 second intervals press START/+30 SEC.
4. To stop the cooking cycle press STOP/CLEAR. To restart, press START/+30 SEC. To clear the previous cooking time press STOP/CLEAR and the time will be shown in the Display Window.

Express Start

To Express Start from 1 to 6 minutes on 100% power:

1. Press any number from 1 to 6 (1 for 1 minute, 2 for 2 minutes, etc.).
The cooking icon and the high power icon will be shown in the Display Window , .
The microwave will start automatically.
2. To increase the time by 30 second intervals press START/+30 SEC any time during the cooking time.



One Touch Cooking

Popcorn

IMPORTANT:

- Do not use this setting if the size of the popcorn bag is less than 1.75 oz. (50 gr)
- Always follow manufacturer's instructions for popcorn. If the time on the preset popcorn button differs from the manufacturers recommended cooking time, do not use the pre-set popcorn button.
- Never leave popcorn cooking unattended

Default Time Setting



1. If the popcorn bag weight is 1.75 oz. (50 g), press POPCORN once. If the bag is 3 oz. (85g) press POPCORN twice. If the popcorn bag size is 3.5 oz (100 g) press POPCORN 3 times. The icons  +  will appear in the Display Window.
2. Press START/+30SEC and the required time will be shown in the Display Window.

Adjusting the Default Time Setting



1. Press POPCORN to select the POPCORN setting. The bag size appears in the Display Window. Press once for 1.75 oz. (50 g), twice for 3 oz. (85 g) or 3 times for 3.5 ozs. (100 g).
2. After choosing the bag size, press MEMORY and the cooking time will be displayed. Press the NUMBER pads to enter the revised time.

3. Press START/+30SEC if you are ready to cook. The new time will be saved automatically or press MEMORY and the new time will be saved.



Potato

1. You can cook 1 to 3 – 8oz. (230g) potatoes at a time.
2. Press POTATO once for 1 potato 8 oz. (230 g), twice for 2 potatoes 1 lb. (460 g) and 3 times for 3 potatoes 24 oz. (690 g).
The icons  +  will appear in the Display Window.
3. Press START/+30SEC. The time will appear in the Display Window and start to countdown.



Pizza

1. You can reheat 1 to 3 - 3oz. (85g) slices of Pizza at a time.
2. Press PIZZA once for 1 slice, twice for 2 slices and 3 times for 3 slices.
The icons  +  will appear in the Display Window.
3. Press START/+30 SEC. The time will appear in the Display Window and start to countdown.



Beverage

1. You can reheat 1 to 3 - 8oz (250 ml) mugs of beverage at a time.
2. Press BEVERAGE once for 1 cup, twice for 2 cups and 3 times for 3 cups.
The icons ,  +  will appear in the Display Window.
3. Press START/+30 SEC. The time will appear in the Display Window and start to countdown.



Soup

1. You can heat up to 16 oz. (475 ml) of soup at a time.
2. Press SOUP once for 4 oz. (120ml), twice for 8 oz. (240 ml), 3 times for 12 oz. (350 ml) and 4 times for 16 oz. (475 ml).
The icons ,  +  will appear in the Display Window.
3. Press START/+30 SEC. The time will appear in the Display Window and start to countdown.



Dinner Plate

1. Press DINNER PLATE once for 9 oz.(250g), twice for 12 oz.(340 g) and 3 times for 18 oz. (500g). The icons ,  + **Oz** will appear in the Display Window.
2. Press START/+30 SEC. The time will appear in the Display Window and start to countdown.

Fresh Vegetables

1. You can cook up to 16 oz. (454g) of fresh vegetables at one time.
2. Press FRESH VEGETABLE once for 4 oz. (112g), twice for 8 oz. (225g) and 3 times for 16 oz. (454 g). The icons ,  + **Oz** will appear in the Display Window.
3. Press START/+30 SEC. The time will appear in the Display Window and start to countdown.



Frozen Vegetables

1. You can cook up to 16 oz (454g) of frozen vegetables at one time.
2. Press FROZEN VEGETABLE once for 4 oz. (112g), twice for 8 oz. (225g) and 3 times for 16 oz. (454g). The icons ,  + **Oz** will appear in the Display Window.
3. Press START/+30 SEC. The time will appear in the Display Window and start to countdown.

Multi-Stage Cooking

Example 1:

To defrost beef of 40 oz. (1.1 kg) first and then cook with full power for 20 minutes.

1. Press DEFROST BY WEIGHT. The icons  +  will appear in the Display Window.
2. Press '4', '0' in sequence
3. Press POWER once, to choose full power
4. Press 2, 0, 0, 0 in sequence
5. Press START/+30 SEC to start cooking

NOTE:

- Time defrost and auto function cooking cannot be set as one of the 2 stages of cooking
- Defrost can be set as the first stage cooking only.

Example 2:

To cook at 5 minutes on power level 9, then 2 minutes 30 seconds on power level 4:

1. Press POWER twice for PL9.
2. Press the 5 0 0 number pads, in sequence. NOTE: The maximum cooking time is 99 minutes and 99 seconds.
3. Press POWER keypad until PL 4 for stage 2 cooking is shown in the Display Window.
4. Enter the cooking time for stage 2 cooking by pressing the 2 3 and 0 on the number pads.
5. Press START/+30SEC to start the cooking process.
6. You will hear a 'beep' when stage 1 finishes and stage 2 begins.
7. At the end of stage 2 you will hear 5 'beeps'.

DEFROSTING

Defrost By Weight

1. Press DEFROST BY WEIGHT. 'dEF1 and  will be shown in the Display Window.
2. Enter the weight between 4 and 100 ozs. (100g – 2.8 kgs) by pressing the Number Pads.
3. Press START/+30 SEC
4. The amount of defrosting time required will be shown in the Display Window.

NOTE: If the weight input is not within 4 – 100 oz. (100g – 2.8 kgs) then the input will be invalid. The microwave will not beep and will not start until valid numbers are input. **NOTE:** The weight can only be input in ounces.

Defrost by Time

1. Press TIME DEFROST. 'dEF2" and  will be shown in the Display Window.
2. Press the number pads to input the defrosting time.
NOTE: The time range is between 00:01 and 99:99.
3. The default microwave power is level 3. If you want to change the power level, press POWER once and the Display Window will show PL 3. Then press the number pad of the power level you want.
4. Press START/+30SEC to start defrosting. The time will be counted down in the Display Window.

NOTE: If the time input is not within 00:01 to 99:99 then the input will be invalid. The microwave will not beep and will not start until valid numbers are input.

CARE AND CLEANING

1. Remove the Turntable. Wash the Turntable in warm, soapy water or in the dishwasher. **NOTE:** Do not put the Turntable directly in water immediately after cooking as it may crack.
2. Remove the Roller Ring and wash in warm soapy water. Let dry before reinstalling in the oven.
3. Food splatters or spilled liquids in the oven cavity should be cleaned after each use. Wipe with a damp cloth. Do not use any sprays or other harsh cleaners. If food has adhered to the oven walls, heat up to two cups of water with lemon juice at high power for 4 minutes or until boiling. Let stand in the microwave for 3 minutes. Remove. Wipe out the oven cavity with a damp cloth.
4. The outside surfaces should be cleaned with a damp cloth. To prevent damage to the operating parts inside the oven, water should not be allowed to seep into the ventilation openings.
5. Wipe the glass door on both sides with a damp cloth to remove any splatters.
6. Wipe the Control panel with a soft damp cloth. Do not allow the Control Panel to become wet. **NOTE:** When cleaning the Control Panel leave the oven door open or activate the Child Lock, to prevent oven from accidentally turning on.

CARE AND CLEANING

PROBLEM	POSSIBLE CAUSE	POSSIBLE REMEDY
Oven will not start	<ul style="list-style-type: none"> a) Electrical cord for oven is not plugged in b) Door is open c) Wrong operation is set 	<ul style="list-style-type: none"> a) Plug into the outlet b) Close the door and try again c) Check instructions
Arcing or sparking	<ul style="list-style-type: none"> a) Materials to be avoided in the microwave oven were used b) The oven is operated when empty c) Spilled food remains in the cavity 	<ul style="list-style-type: none"> a) Use microwave-safe cookware only b) Do not operate with oven empty c) Clean cavity with wet cloth (See 'Care and Cleaning' section)
Unevenly cooked foods	<ul style="list-style-type: none"> a) Materials to be avoided in the microwave oven were used b) Food is not defrosted completely c) Cooking time, power level is not suitable d) Food is not turned or stirred 	<ul style="list-style-type: none"> a) Use microwave-safe cookware only b) Completely defrost food c) Use correct cooking time, power level d) Turn or stir food
Overcooked foods	<p>Cooking time, power level is not suitable</p>	<p>Use correct cooking time, power level</p>
Undercooked foods	<ul style="list-style-type: none"> a) Materials to be avoided in the microwave oven were used b) Food is not defrosted completely c) Oven ventilation ports are restricted d) Cooking time, power level is not suitable 	<ul style="list-style-type: none"> a) Use microwave-safe cookware only b) Completely defrost food c) Check to see that the oven ventilation ports are not restricted d) Use correct cooking time, power level
Improper defrosting	<ul style="list-style-type: none"> a) Materials to be avoided in the microwave oven were used b) Cooking time, power level is not suitable c) Food is not turned or stirred 	<ul style="list-style-type: none"> a) Use microwave-safe cookware only b) Use correct cooking time, power level c) Turn or stir food

LIMITED WARRANTY

SWG Canada warrants that this appliance shall be free from defects in material and workmanship for:

- one year on parts and labour with proof of purchase
- 7 years on the Magnetron, labour not included after the initial one year.

During the 'in-warranty' period, defective products will be repaired or replaced at the discretion of the retailer and/or SWG Canada. This warranty covers normal domestic usage and does not cover damage which occurs in shipment or failure which results from alteration, accident, misuse, abuse, glass breakage, neglect, commercial use or improper maintenance.

A defective product should be returned to the original place of purchase within the retailer's stipulated return/exchange period*. If you are unable to have a defective product replaced under warranty by the retailer, please check our website at "www.salton.com" for the service centre nearest you. You may contact us for assistance by mail, e-mail, fax or telephone as listed below.

To ensure prompt 'in-warranty' service, securely package and return the product to us prepaid. Be sure to include the original proof of purchase and a description of the defect, along with your address and postal code.

For repairs not covered by the warranty, please contact us for assistance.

salton[®]

SWG CANADA

Division of Salton Appliances (1985) Corp.

Customer Service Department

81A Brunswick

Dollard-des-Ormeaux

Quebec, Canada H9B 2J5

Website: www.salton.com

E-mail: service@salton.com

Fax: 514-685-8300

Tel: 514-685-3660

* Return/exchange policies at each retailer vary and may differ from the SWG Canada 1 year limited warranty period.