



salton® JUMBO
coffee maker *java*



Instruction Booklet

Model: FC1667

IMPORTANT SAFEGUARDS

When using electrical appliances, basic safety precautions should always be followed including the following:

1. Read all instructions.
2. Do not touch hot surfaces. Use handles or knobs.
3. To protect against electrical hazards, do not immerse cord, plugs, or the appliance in water or other liquid.
4. Close supervision is necessary when any appliance is used by or near children. Children should be supervised to ensure that they do not play with the appliance.
5. This appliance is not intended for use by persons (including children) with reduced physical, sensory or mental capabilities or lack of experience and knowledge, unless they have been given supervision or instruction concerning the use of the appliance by a person responsible for their safety.
6. Unplug from outlet when either the appliance or display clock is not in use and before cleaning. Allow to cool before putting on or taking off parts, and before cleaning the appliance.
7. **DO NOT** operate any appliance with a damaged cord or plug or after the appliance malfunctions, or is dropped or damaged in any manner. Return appliance to the manufacturer for examination, repair or electrical or mechanical adjustment. All servicing, other than cleaning, should be performed by an authorized service representative. See Warranty section.
8. To disconnect, ensure that the Coffee Maker is off then remove the plug from the wall outlet. Always hold the plug, never pull the cord.
9. The use of accessories or attachments not recommended by Salton may result in fire, electric shock or injury.
10. **DO NOT** use outdoors.
11. Place the Coffee Maker on a flat level surface. **DO NOT** let cord hang over edge of table or counter, or touch hot surfaces.
12. **DO NOT** place on or near a hot gas or electric burner, or in a heated oven.
13. **DO NOT** use appliance for other than intended use.
14. **DO NOT** leave unit unattended while in use.
15. **DO NOT** turn on the coffee maker without water in the reservoir.
16. **DO NOT** place the carafe on a wet or cold surface or in a microwave oven.
17. **DO NOT** use the carafe if it is cracked or has a loose or weakened handle.

18. **DO NOT** clean the carafe with cleansers, steel wool pads or other abrasive material.
19. **DO NOT** open the water reservoir cover or the filter basket holder when coffee is brewing. Scalding may occur if these parts are opened during the brew cycle.
20. Extreme caution must be used when moving an appliance containing hot liquids.
21. The carafe is designed for use with this appliance. It must never be used on a range top.
22. Never leave the empty carafe on the 'Keep Warm Plate' as the carafe is likely to crack.
23. Any maintenance other than cleaning should be performed by an authorized service facility.

SAVE THESE INSTRUCTIONS

HOUSEHOLD USE ONLY

POLARIZED PLUG

This appliance has a polarized plug (one blade is wider than the other). To reduce the risk of electric shock, this plug will fit in a polarized outlet only one way. If the plug does not fit fully in the outlet, reverse the plug. If it still does not fit, contact a qualified electrician. Do not modify the plug in any way.

WARNING: To reduce the risk of fire or electric shock do not remove the bottom cover. No user serviceable parts inside. Repair should be done by authorized personnel only.

DESCRIPTION OF PARTS

- 1) Lid
- 2) Main Housing
- 3) Filter Holder (removable)
- 4) Reusable Filter
- 5) Water Reservoir
- 6) Water Level Window
- 7) Control Panel
 - a) Digital Display
 - b) ON/OFF  Button
 - c) HR - Hour time set Button
 - d) PROG Button
 - Press to set the current time or the delay start time
 - e) MIN - Minute time set Button
 - f) AUTO Button
 - g) On Indicator Light
 - h) Auto Indicator Light
- 8) Carafe
- 9) Keep Warm Plate

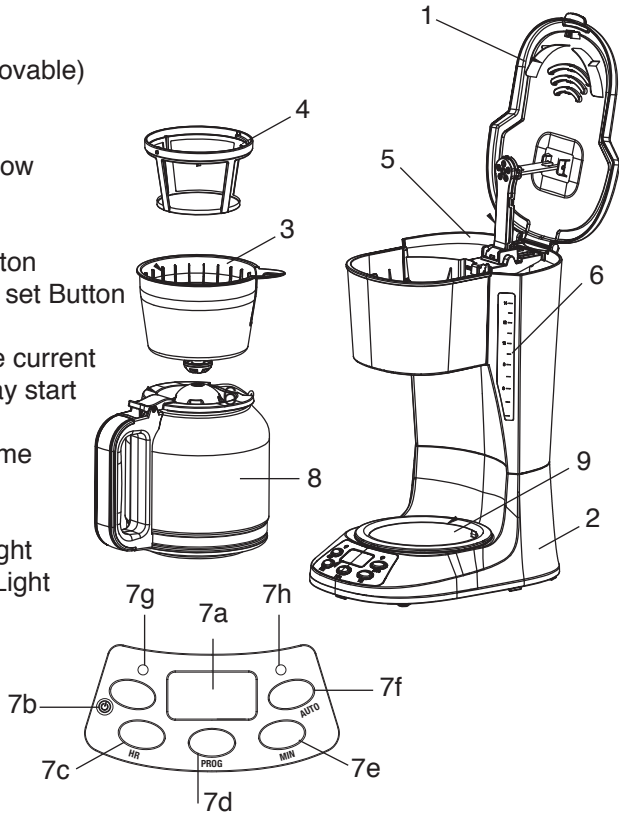

BEFORE FIRST USE

Wash the Carafe, Filter Holder and Permanent Filter in warm soapy water. Rinse thoroughly and dry. Wipe the Main Housing with a soft damp cloth. DO NOT immerse the Main Housing in water or any other liquid.

Prior to brewing coffee for the first time run the machine with water only. Follow the directions in the HOW TO USE section omitting the coffee and Permanent Filter.





HOW TO USE

To Set the Clock

1. Plug into a 120 Volt AC wall outlet.



2. Press the PROG Button once and the word CLOCK will appear in the upper right corner of the display.
3. Press the HR and MIN Buttons to set the time.
 - a) The clock will show a 12 hour cycle and the AM and PM will change.
 - b) To scroll through the numbers faster, press and hold the HR and MIN Buttons.

Immediate Brewing

1. Lift the Lid and fill the Water Reservoir with fresh cold water for the desired number of cups. Fill the Water Reservoir by filling the Carafe and pouring water into the Water Reservoir.
NOTE: Do not fill above the maximum Water Line (14) or less than the minimum Water Line (4) indicated on the Carafe and Water Reservoir.
2. Remove the Reusable Filter and fill with the desired amount of ground coffee.
NOTE: Use coffee that is ground specifically for automatic drip coffee makers. Usually one Coffee Measuring Scoop or a level tablespoon of ground coffee is used for each cup of coffee. Adjust the amount to your personal taste.
3. Reposition the Reusable Filter and close the Lid.
NOTE: If the Lid does not close completely, ensure that the Filter Holder and Reusable Filter are properly seated in position.
4. Place the Carafe with Lid on the Keep Warm Plate.
5. Press the ON/OFF  Button and the On Indicator Light will illuminate and the brew cycle will start. (To use the delay start function follow the directions in the “Delayed Brewing section” below)
NOTE: The brew cycle can be interrupted by pressing the  Button at any time. Hot water which has already entered the Filter will continue to drip until the Filter is empty so long as the Carafe remains in position. If you press the ON/OFF  Button again the brew cycle will continue.
6. In a few minutes the coffee will be brewed and the Coffee Maker will automatically switch over to ‘Keep Warm’ mode for approximately the next two hours. **NOTE:** The keep warm time will be 2 hours less the amount of time for the brew cycle. The ‘Keep Warm Cycle’ will shut off automatically and the ‘On’ Indicator Light will go out at the end of the 2 hours. If you wish to turn off the Coffee Maker before 2 hours has elapsed, press the ON/OFF  Button once.
7. See the ‘Pause & Serve’ section to pour a cup of coffee before the brew cycle ends.

8. Always turn off the Coffee Maker and unplug from the wall outlet when not in use.

Delayed Brewing

1. Fill the Water Reservoir with fresh cold water for the desired number of cups. Fill the Water Reservoir by first filling the Carafe and then pouring water into the Water Reservoir.
NOTE: Do not fill above the maximum Water Line (14) or less than the minimum Water Line (4) indicated on the Carafe and Water Reservoir.
2. Remove the Reusable Filter and fill with the desired amount of ground coffee.
NOTE: Use coffee that is ground specifically for automatic drip coffee makers. Usually one Coffee Measuring Scoop or a level tablespoon of ground coffee is used for each cup of coffee. Adjust the amount to your personal taste.
3. Reposition the Reusable Filter and close the Lid.
NOTE: If the Lid does not close completely, ensure that the Filter Holder and Reusable Filter are properly seated in position.
4. Place the Carafe with Lid on the Keep Warm Plate.
5. Press the PROG Button twice to set the time for the Delayed Brew Cycle. (NOTE: The word TIMER will appear in the top left corner of the display)
6. Press the HR and MIN Buttons until the desired brew start time displays. Ensure that the AM or PM display is correct.
7. Press the AUTO Button and the green AUTO Indicator Light will illuminate.
8. The Digital Display will switch back to the current time when the AUTO Button is released. To see the Delayed Brew start time press the PROG Button once.
NOTE: You can cancel the delay start time by pressing the ON/OFF  Button.
9. Once the clock reaches the preset time to start the Brew Cycle, the green AUTO Indicator Light will go out and the red ON Indicator Light will illuminate and the brew cycle will start.
10. After the brew cycle is finished, the Coffee Maker will automatically switch over to 'Keep Warm' mode for the next two hours. The 'Keep Warm Cycle' will shut off automatically and the 'On' Indicator Light will go out at the end of the 2 hours. **NOTE:** The keep warm time will be 2 hours less the amount of time for the brew cycle. If you wish to turn off the Coffee Maker before 2 hours has elapsed, press the ON/OFF  Button once and unplug the coffee maker from the wall outlet.

'PAUSE & SERVE' FEATURE

The 'Pause & Serve' feature allows you to pour a cup of coffee before the brew cycle has finished. Remove the Carafe slowly to temporarily stop the flow of coffee. Quickly pour a cup of coffee and reposition the Carafe securely on the Keep Warm Plate.



NOTE: Do not remove the Carafe for longer than 30 seconds.

CARE AND CLEANING

- 1) Unplug the Coffee Maker and allow it cool before cleaning.
- 2) Remove the Reusable Filter and the Filter Holder from the Coffee Maker.
- 3) The Filter Holder, Permanent Filter and Carafe can be washed in warm soapy water. **NEVER use abrasive cleansers on any part of the Coffee Maker.**
- 4) Wipe the Main Housing and Warming Plate with a soft damp cloth. **NEVER IMMERSE THE MAIN HOUSING IN WATER OR ANY OTHER LIQUID.**
- 5) All servicing, other than cleaning, should be performed by an authorized service representative. See Warranty section.

Descaling

Over a period of time, minerals and calcium found in water will accumulate in your Coffee Maker and may affect its operation. The appliance should be cleaned approximately every six months, depending on water conditions. Use distilled vinegar in the following manner to remove the mineral deposits.

1. Fill the Water Reservoir to the maximum Water Line (14) with equal parts of white vinegar and cold water. Close the Lid.
2. Place the Filter Holder into position.
3. Place the Carafe with Lid on the Warming Plate.
4. Press the ON/OFF  Button once and the Coffee Maker will start.
5. Let the whole quantity of the vinegar/water solution run through the machine, then turn the Coffee Maker off by pressing the ON/OFF  Button. (The red On Indicator Light will turn off.)
6. Repeat the above steps using cold water to rinse away any residual vinegar. Repeat twice.

HELPFUL HINTS

1. Regularly clean the Coffee Maker to ensure great tasting coffee. Follow the directions in the Care & Cleaning Section.

2. Store unused ground coffee in a cool dry place. After opening a package of ground coffee reseal it tightly and store in the refrigerator to maintain its freshness.
3. For optimum coffee taste buy whole coffee beans and grind them just before brewing.
4. Reheating coffee is not recommended. Coffee is at its peak flavor immediately after brewing.

A short supply cord is provided to reduce the hazards of becoming entangled in or tripping over a long cord. Extension cords may be used if care is exercised in their use. If an extension cord is used, the marked electrical rating of the detachable power-supply cord or extension cord should be at least as great as the electrical rating of the appliance. If the appliance is of the grounded type, the extension cord should be a grounded 3-wire cord. The extension cord should be arranged so that it will not drape over the counter top or table top, where it can be pulled on by children or tripped over.

LIMITED WARRANTY

****The original sales receipt is the only acceptable proof of purchase****

Salton Canada warrants that this appliance shall be free from defects in material and workmanship for a period of two (2) years from the date of original purchase. Salton Canada, at its sole discretion during this warranty period, will repair or replace a defective product or issue a refund. Any refund to the purchaser will be at a pro-rated value based on the remaining period of the warranty. All liability is limited to the amount of the purchase price. This warranty covers normal domestic usage and does not cover damage which occurs in shipment or failure which results from alteration, accident, misuse, abuse, glass breakage, neglect, improper maintenance, use contrary to the operating instructions or commercial use. This warranty is not available to retailers or other commercial purchasers or owners.

This warranty does not include the cost of shipping, which is to be borne by the customer.

TO OBTAIN PROMPT WARRANTY SERVICE:

Contact one of our many Service Centers found on our website
www.salton.com/customer-care

or

Securely package and return the appliance to us. Please enclose:

- Original proof of purchase
- The completed form below with a \$12.50 Return Shipping & Handling fee – either a cheque, money order or credit card (A personal cheque will delay return shipping by 2-3 weeks)

For added protection, we suggest that you use an insured delivery service with tracking information when returning your product. Salton Canada will not be held responsible for in-transit damage or for packages that are not received.

This warranty does not include the cost of shipping, which is to be borne by the customer.

.....

Name _____

Address _____

City _____ Prov/State _____ Postal/Zip Code _____

Daytime Phone No. _____ Email _____

Product defect: _____

Type of payment Cheque/Money Order Visa MasterCard

Name on card _____ Expiry Date _____ CSV No _____

Card No. _____

To contact our Customer Service Department:

SALTON CANADA
81A Brunswick,
Dollard-des-Ormeaux, Quebec H9B 2J5
Canada

Telephone: 514-685-3660 (Ext. 226)
E-mail: service@salton.com
Fax: 514-685-8300
www.salton.com